



SCHLAGE

AL Series

Cylindrical locks





Put your trust in the name you know

Contents

4	AL Series introduction and performance features
5	Exploded view
6	Lever designs
7	Lever finishes and door handing
8-9	Lock functions
10	Cylinder types
11	Standard cylinders
11	Primus XP high security cylinders
12	Full size interchangeable core
12	Small format interchangeable core
12	IC conversion kits
12	IC installation tool
13	Latches
14	Strikes
14	Rabbeted latch and strike kit
15	Specifications and certifications

Pictured here: Saturn lever shown in 626 satin chrome

Cover photo: Neptune lever shown in 626 satin chrome finish

For more than 90 years, Schlage has been creating the strongest and most technologically advanced security products for schools, hospitals, hotels, commercial and institutional buildings, multi-family properties and homes. From durable mechanical locks to comprehensive electronic access control solutions and biometrics, Schlage provides protection at critical moments – when property and personal security are at stake. With a wide range of products, styles and finishes, Schlage has products for the most demanding project specifications. In public buildings, in the workplace, and in homes, at the end of the day Schlage stands for one thing: strong.

Real security is knowing exactly what you want and getting it

When you know exactly what you want, you don't want to waste time finding out whether it meets your project specifications. That's why we offer the world's largest team of hardware specification writers to help you and your clients turn your vision into reality. And when it comes to products, our commercial suiting options, wide variety of lever designs and rich selection of finishes give you the tools you need to make your projects perfect. You know what you want. With Schlage, you can be sure you'll get it.

Safety, security and confidence

When you choose a Schlage lock, you can be sure you've done the job right, the first time. After all, our products are among the most durable and dependable on the market today. Our locks are easy to install, and simple to repair and maintain. That means fewer callbacks for you, and total safety and security for your customers.



AL Series

Dependable performance for high traffic commercial applications

At Schlage, we know that every product you specify has to stand up to constant use, while meeting your needs for security at every level. Our AL Series locks are designed to deliver ADA compliant accessibility and constant, reliable performance. The AL Series is best for buildings with medium to high traffic flow, such as interior office doors, banks, retail spaces and hotel guest areas. With a Grade 2 ANSI rating, and styles and finishes to suit your building's design, the AL Series fits right where you need it.

Pictured here: Jupiter lever shown in 626 satin chrome



We don't compromise on security

The safety and security of your clients' buildings is something we take very seriously. That's why every Schlage lock and deadbolt undergoes intensive testing to determine its ANSI grade level:

- Cycle tests
- Resistance tests
- Door impact tests
- Warped door tests
- Bolt strength tests

We pay attention to these details so you can focus on creating a functional and aesthetically pleasing environment for your clients. In fact, every one of our AL Series locks meets ANSI Grade 2 standards for safety.

The lever that looks as good as it performs

- Cold-rolled steel, machined and threaded hubs, and locking nuts prevent the loosening of the lockset by securely bolting the chassis to the door
- Large diameter of mounting plate and rose covers new ANSI hollow metal door cutout
- Patented door range adjuster allows quick and easy adjustment for doors ranging from 1³/₈" to 1⁷/₈" (35 mm to 48 mm) thick

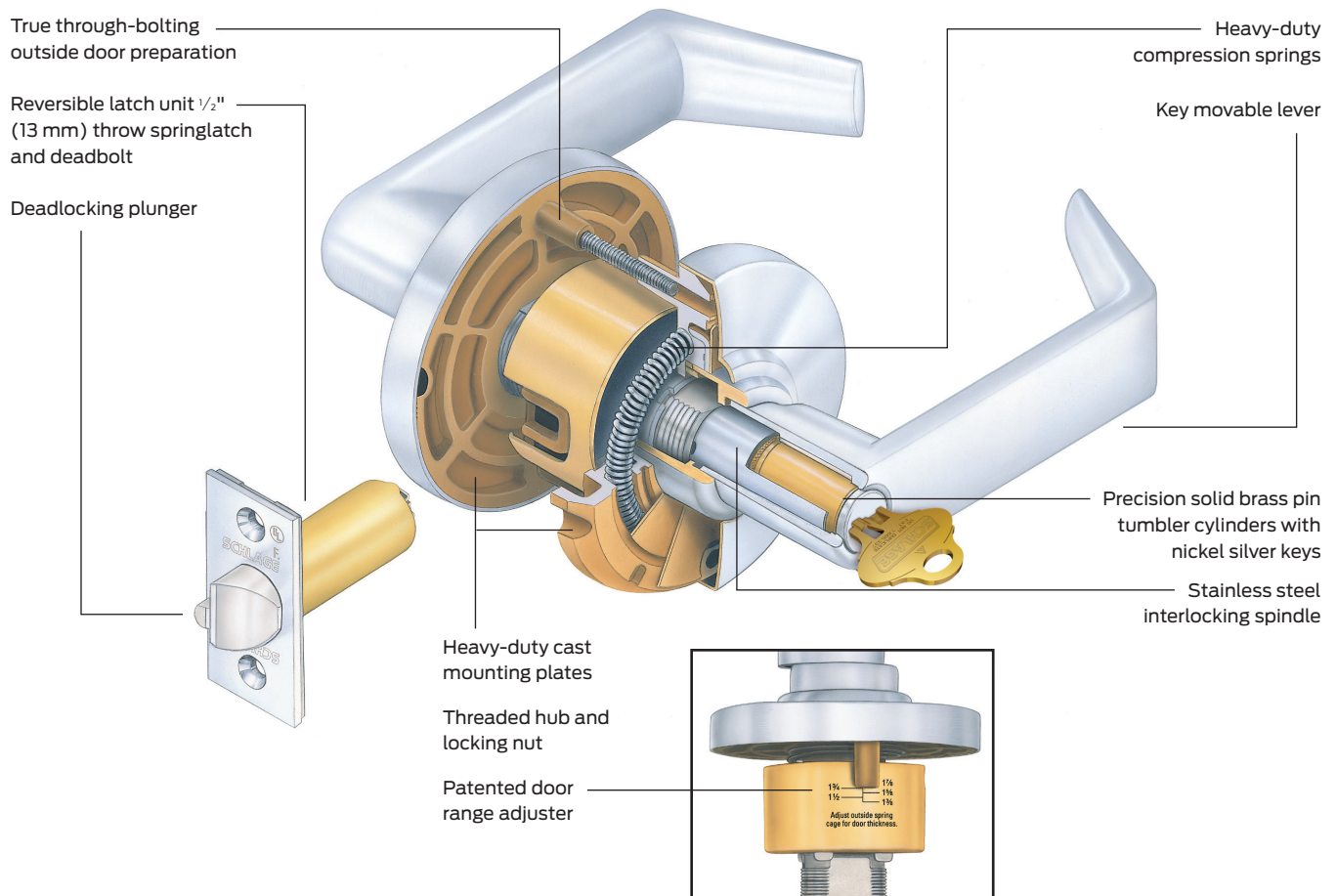

AL Series lever designs

Jupiter (JUP)

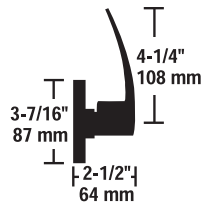

Symbol: JUP

Material: Pressure cast zinc lever; wrought brass or bronze rose

Suites: S Series **JUPITER**, ND Series **ATHENS** and L Series **07** designs



Neptune (NEP)

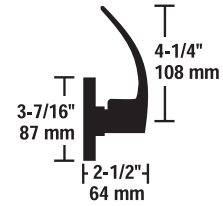

Symbol: NEP

Material: Pressure cast zinc lever; wrought brass or bronze rose

Suites: S Series **NEPTUNE**, ND Series **SPARTA** and L Series **17** designs



Omega (OME)

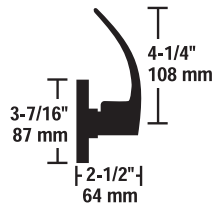

Symbol: OME

Material: Pressure cast zinc lever; wrought brass or bronze rose

Suites: ND Series **OMEGA** and L Series **OMEGA** designs



Saturn (SAT)

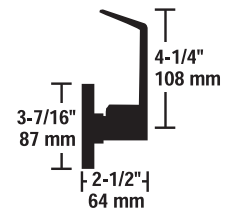

Symbol: SAT

Material: Pressure cast zinc lever; wrought brass or bronze rose

Suites: S Series **SATURN**, H Series **LEVON**, ND Series **RHODES** and L Series **06** designs

Options: Tactile warning



Tactile warning



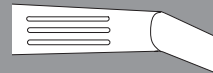



Milled



Order as follows:
BSA for Saturn

Only available on outside lever, unless otherwise specified

All designs shown in 626 satin chrome

-  = Standard cylinder.
-  = FSIC - Full size interchangeable core option.
-  = SFIC - Small format interchangeable core option.
-  = Complies with ADA accessibility guidelines.
-  = Antimicrobial coating available on 626 finish only.
-  = Meets California code for 1/2" or less return to the door.
-  = Extended factory lead time.

Lever finishes

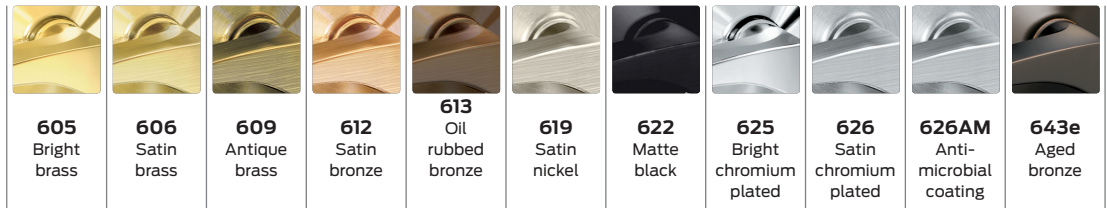

AL Series locks											
Jupiter*	•	•	•	•	•	•	•	•	•	•	•
Neptune*	•	•	•	•	•	•	•	•	•	•	•
Omega*	•	•	•	•	•	•	•	•	•	•	•
Saturn	•	•	•	•	•	•	•	•	•	•	•

*Not available in 609 finish for FSIC and SFIC.

e = an equivalent finish to the BHMA standard.

Door handing

All Schlage locks are reversible. Hand information is necessary to ensure proper cylinder orientation in keyed functions, and finish of latchbolt and strike for locks that are to be installed on reverse bevel doors. Follow the diagram to correctly determine the hand of the door.

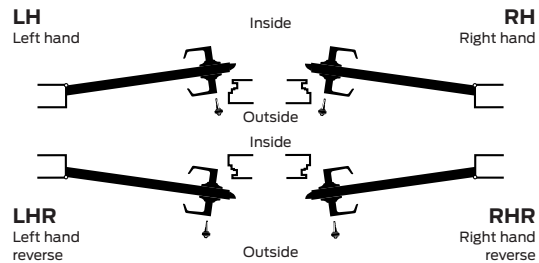

ADA-compliant products



In compliance with the American National Standards Institute (ANSI A117.1) and the Americans with Disabilities Act (ADA), Schlage Lock Company offers a wide selection of locks designed for the needs of the physically challenged. This act is designed to provide protection for people with disabilities.

Product information and specifications contained in this catalog are subject to change without notice. Please consult the factory.

Lock functions

ANSI A156.2 Series 4000 Grade 2

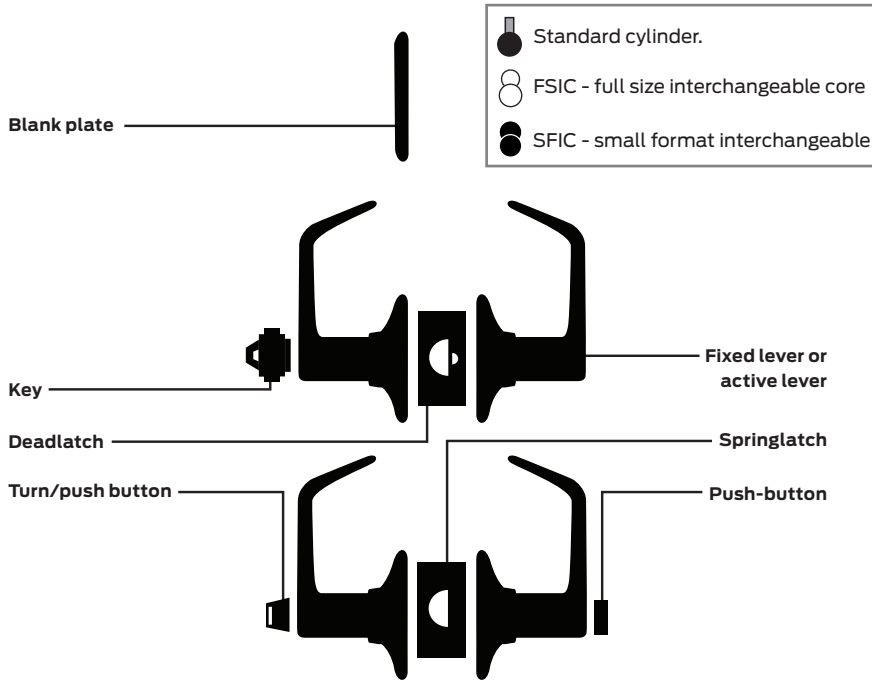

Non-keyed functions

Schlage ANSI

AL10S **F75**

Passage latch

- Both levers always unlocked
- Inside lever always free for immediate egress

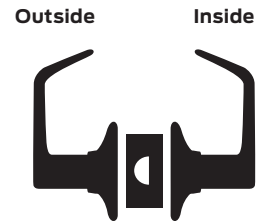

Schlage ANSI

AL25D -

Exit lock

- Blank plate outside
- Inside lever always unlocked
- Inside lever always free for immediate egress
- Specify door thickness

Outside Inside



Schlage ANSI

AL40S **F76**

Bath/bedroom privacy lock

- Push-button locking
- Can be unlocked from outside with small screwdriver
- Turn inside lever or close door to release button
- Inside lever always free for immediate egress

Outside Inside



Schlage ANSI

AL44S -

Hospital privacy lock

- Push-button locking
- Unlock from outside by turning emergency turn-button
- Turn inside lever or close door to release button
- Inside lever always free for immediate egress

Outside Inside

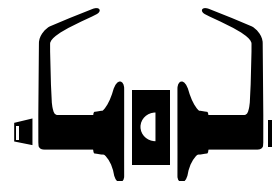

Lock functions

ANSI A156.2 Series 4000 Grade 2

Keyed functions

Schlage ANSI
AL170 **—**

Single dummy trim

- Single dummy trim for one side of door
- Used for door pull or as matching inactive trim

Outside or Inside



Schlage ANSI
AL50PD **F82**

Entrance/office lock

- Push-button locking
- Push-button locks outside lever until it is unlocked with a key or by rotating the inside lever
- Inside lever always free for immediate egress

Outside Inside

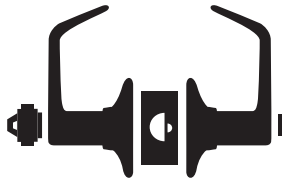

Schlage ANSI
AL53PD **F109**

Entrance lock

- Turn/push-button locking: pushing and turning button locks outside lever, requiring use of a key until the button is manually unlocked
- Push-button locking: push-button locks the outside lever until it is unlocked by key or by turning the inside lever
- Inside lever always free for immediate egress

Outside Inside

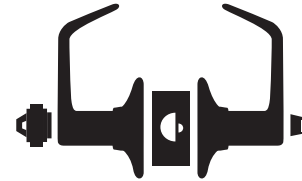

Schlage ANSI
AL70PD **F84**

Classroom lock

- Outside lever is locked and unlocked by key
- Inside lever is always unlocked
- Inside lever always free for immediate egress

Outside Inside

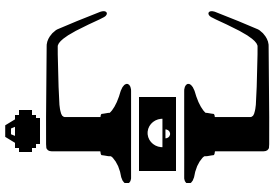

Schlage ANSI
AL80PD **F86**

Storeroom lock

- Outside lever is fixed
- Entrance by key only
- Inside lever is always unlocked
- Inside lever always free for immediate egress

Outside Inside

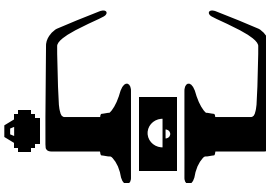

Schlage ANSI
AL85PD **F93**



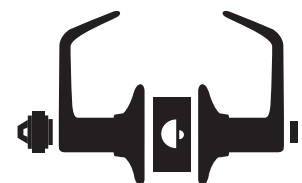

Faculty restroom lock (with indicator cylinder)

- Outside lever is fixed
- Entrance by key only
- Push button on inside lever activates visual occupancy indicator, allowing only the emergency masterkey to operate
- Rotate inside lever or close door to release visual occupancy indicator
- Rotation of inside spanner button provides lockout feature by keeping indicator thrown
- Inside lever always free for immediate egress

Outside Inside



Cylinders and key systems

Administrative Security	Schlage Everest 29™					
	Schlage Classic	End user exclusive nationwide	4N		9N	
		End user exclusive within time zone/country	4Z		9Z	
		End user exclusive within zip code	3G		9G	
		End user controlled; non-exclusive	3U		9U	
		Dealer exclusive within time zone/country	2		8	
		Dealer exclusive within zip code	1+		7	
		Authorized dealer only; non-exclusive	1			
End user controlled; non-exclusive						
Authorized dealer only						
No authorization						
 OPEN Schlage Classic FSIC & Conventional <ul style="list-style-type: none">Duplicate anywhere		 OPEN Schlage Everest 29 S FSIC & Conventional <ul style="list-style-type: none">Patented designCheck pin in cylinder		 RESTRICTED Schlage Everest 29 R SFIC & Conventional* Schlage Everest 29 T FSIC & Conventional <ul style="list-style-type: none">Requires letter of authorizationPatented designCheck pin in cylinder		
Primus XP RESTRICTED Schlage Classic FSIC & Conventional <ul style="list-style-type: none">5 levels of side bit milling exclusivityPatent protection to 2024Independent sidebar and finger pin locking mechanisms			Primus XP RESTRICTED Schlage Everest 29 R Conventional* Schlage Everest 29 S FSIC & Conventional Schlage Everest 29 T FSIC & Conventional <ul style="list-style-type: none">5 levels of side bit milling exclusivityPatent protection to 2029Independent sidebar and finger pin locking mechanisms			
UL 437 Option UL listed security improvements available with Primus XP <ul style="list-style-type: none">Hardened steel drill pinsProven pick and drill resistantWithstands extreme physical attack						
Physical Security						

COMPARABLE ELECTRONIC SECURITY - Ensure your credential is as secure as your keyway

Proximity credentials <ul style="list-style-type: none">Easily duplicated	MIFARE Classic® smart credentials <ul style="list-style-type: none">Secure encrypted data & communicationsDifficult to duplicate	MIFARE Plus® & MIFARE® DESFire® EV1 smart credentials <ul style="list-style-type: none">Advanced data encryption makes duplication nearly impossibleMost secure credentials available from Schlage
---	---	---

* As SL cylinder that accepts SFIC key

Primus XP access control and high security cylinders

Primus XP access control and high security cylinders are available to add patented key control and varying degrees of geographical exclusivity to most Schlage 6-pin key systems, whether Everest 29 or Classic keyways.

In addition to a conventional pin tumbler mechanism, Primus cylinders incorporate a patented finger pin and sidebar design, providing a “dual-locking” cylinder that is virtually pick-proof. Resistance to drilling and other physical attack is optional by specifying 20-500 Series UL437 Listed cylinders.

Classic Primus XP cylinders are recommended for upgrading existing Classic key systems. Due to its extended patent life, the newly designed Everest 29 Primus XP is recommended for new key systems and for upgrading existing Everest key systems. Specify keyway to differentiate between Everest 29 and Classic. Example: C or CP (Classic) vs. S123 (Everest 29).

Visit us.allegion.com for more information.

Standard cylinders

Standard cylinders are available in Classic keyways or in patented Everest 29 keyways.

Specify keyway to differentiate between Everest 29 and Classic.

Example: C (Classic) vs. S123 (Everest 29).

Standard cylinders - options

- Conventional 6-pin cylinder (standard)
- Primus high security cylinder
- Primus UL437 listed high security cylinder
- Conventional 6-pin AL85 function with occupancy indicator

Available in 606, 622, 626 and 643e finish only.
Everest 29 S123 keyway standard.



Example of lock with cylinder for most functions

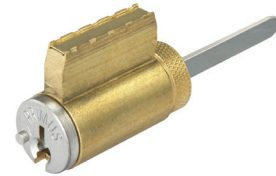

AL85 cylinder with occupancy indicator

New Everest SL cylinder

A full-size KIL cylinder that pins to the Schlage SFIC keyways

- Uses pick resistant L pins
- SFIC system owners can gain geographic exclusivity with Primus XP
- Achieves about 57,000 more combinations than a 6-pin system

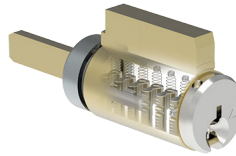

Everest SL cylinder

Full size interchangeable core 8

Schlage interchangeable core (IC) locksets allow immediate rekeying at the door simply by using the special control key to replace the core in seconds.

IC locksets are available in Saturn design only.

Full size interchangeable cores - options

(for JD suffix locksets)

- Conventional core
- Primus XP high security core

Available in 606, 622, 626 and 643e finish only.
Everest 29 S123 keyway standard.



Full size core



FSIC can be integrated into any 5 or 6-pin Schlage key system.

Small format interchangeable core

The SFIC version is designed for Schlage Everest 29 R family restricted keyway cores and is also completely compatible with Best®, Falcon and other competitive small format cores.

Small format interchangeable cores - options

(For BD suffix locksets)

- 7-pin uncombined Everest 29 R family restricted keyways
- 7-pin combined Everest 29 R family restricted keyways
- 6-pin uncombined Falcon/Best keyways
- 7-pin uncombined Falcon/Best keyways
- Disposable plastic construction core



Small format core

Available in 606, 622, 626 and 643e finish only.
Specify keyway for existing systems.

80-033 and 80-043 cores are available in A, D, E, F, G, H, J, K, L, and M keyways.

80-036 and 80-037 restricted keyway cores require a letter of authorization from the end user. Schlage assigns the keyway when establishing new Everest 29 restricted key systems.

IC conversion kits

It is easy to convert standard AL Series locksets to accept Schlage full size interchangeable cores by changing the lever and adding the parts shown.

Conversion to SFIC requires different components, as well as dismantling the lockset to replace internal parts. No kits are available for this purpose.

Interchangeable core components - options

- Conversion kit: driver, retainer, lever, core *
- Conversion kit: driver, retainer, lever
- Driver, retainer
- Lever only (Saturn)*
- IC installation tool

IC installation tool
M504-413

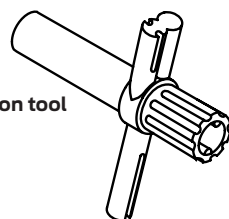

Full size IC conversion

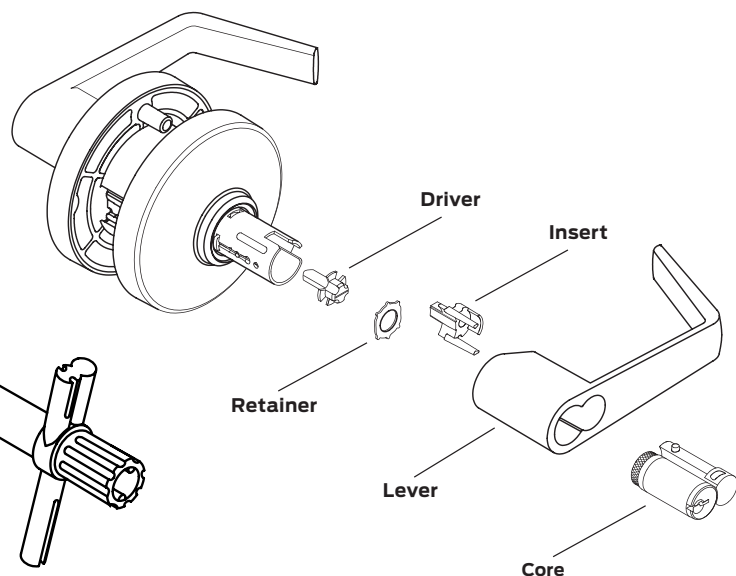

*Specify finish.

Latches

AL Series latches are adjustable for flat or beveled edge doors. Latches and strikes are furnished in brass, bronze or chrome finishes compatible with lock trim. When ordering separately, specify quantity, part number, and finish. Standard latches shown in bold type.

Latches

Backset	Faceplate description	Hsg dia	Deadlatch 1/2" (13 mm) throw	Springlatch 1/2" (13 mm) throw
2 3/8" (60 mm)	1" x 2 1/4" (25 mm x 57 mm) square corner	7/8" (22 mm)	11-085	11-068
	1" x 2 1/4" (25 mm x 57 mm) 1/4" (6 mm) radius round corner	7/8" (22 mm)	11-088	11-069
	1" (25 mm) circular drive-in (non-UL) 605 and 626 finishes only	1" (25 mm)	11-104	11-110
2 3/4" (70 mm)	1" x 2 1/4" (25 mm x 57 mm) square corner	7/8" (22 mm)	11-091	11-111
	1 1/8" x 2 1/4" (29 mm x 57 mm) square corner, standard	1" (25 mm)	11-096	11-116
	1" x 2 1/4" (25 mm x 57 mm) 1/4" (6 mm) radius round corner 605 and 626 finishes only	7/8" (22 mm)	11-092	11-112
	1" (25 mm) circular drive-in (non-UL)	1" (25 mm)	11-105	11-113
3 3/4" (95 mm)	1 1/8" x 2 1/4" (29 mm x 57 mm) square corner	1" (25 mm)	11-103	11-118
5" (127 mm)	Backset extension link*	7/8" (22 mm)	41-005*	

*Backset extension link 41-005 must be used with 2 3/8" backset latches.

Square corner latches

Springlatch

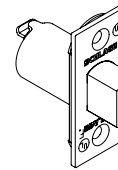

Deadlatch

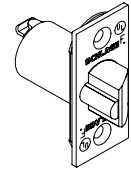

Round corner latches

Springlatch

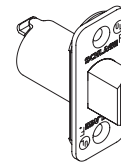

Deadlatch

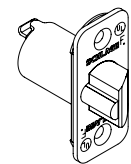

Drive-in latches

Springlatch

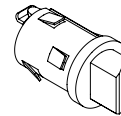

Deadlatch

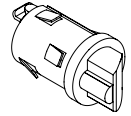

Long backsets

Backsets 5" require extension links. AL Series locks with long backsets are normally furnished with 1" faceplates and 7/8" housings. Links installed in 1" latch holes require one G506-815 sleeve (order separately) to join latch and link.

Latch front adapter

A501-878

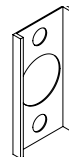

Used to convert 1" wide square front faceplates for 1 1/8" wide door preparations. Furnished in black plastic. Order in units of 100 each.

5" extension link

41-005

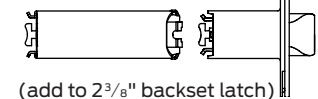

(add to 2 3/8" backset latch)

Sleeve

G506-815
(order separately)



Door reinforcement

Reinforcing unit is required to reinforce and help prevent the collapse of hollow metal doors when locksets are tightly mounted. This kit should be used with long backsets for AL Series lock installations in hollow metal doors to prevent lateral movement of the latchbolt. Specify door thickness, 1 3/8" (35 mm) or 1 3/4" (44 mm), when ordering reinforcement kits.

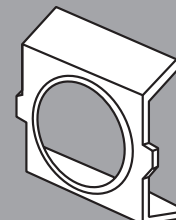

Reinforcement kit

37-001

Kit includes:

Reinforcement

A501-566 for 1 3/4" doors or
A501-565 for 1 3/8" doors

Strikes

All Schlage strikes are furnished complete with screws. The 10-025 standard AL Series strike has a 1³/₁₆" (30 mm) lip. Standard strikes shown in bold type.

ANSI strike – standard

10-025
1¹/₄" x 4⁷/₈" x 3³/₃₂"
(32 mm x 124 mm x 2 mm)



T-Strike

10-001
1¹/₈" x 2³/₄" x 3³/₃₂"
(29 mm x 70 mm x 2 mm)

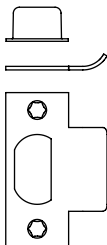

Strikes

Number	Lip length	Description
10-001	1", 1 ¹ / ₈ " (std), 1 ¹ / ₄ ", 1 ¹ / ₂ ", 1 ³ / ₄ ", 2" (25 mm, 29 mm, 32 mm, 38 mm, 44 mm, 51 mm)	1 ¹ / ₈ " x 2 ³ / ₄ " (29 mm x 70 mm) square corner, box, standard
10-004	1 ¹ / ₈ " (29 mm)	1 ¹ / ₈ " x 2 ³ / ₄ " (29 mm x 70 mm) 1 ¹ / ₈ " (3 mm) radius, round corner
10-025	1³/₁₆" , 1³/₈" (30 mm, 35 mm)	1¹/₄" x 4⁷/₈" (32 mm x 124 mm) ANSI
10-026	1 ¹ / ₈ " (29 mm)	1 ⁵ / ₈ " x 2 ¹ / ₄ " (41 mm x 57 mm) full lip, square corner
10-027	1 ¹ / ₈ " (29 mm)	1 ⁵ / ₈ " x 2 ¹ / ₄ " (41 mm x 57 mm) full lip, 1 ¹ / ₄ " (6 mm) radius, round corner
10-058	1 ⁷ / ₃₂ " (31 mm)	1 ³ / ₄ " (44 mm) circular, adjustable
K510-066	—	Box for ANSI strike

*Use with 2³/₄" square corner strikes only.

Rabbeted latch and strike kit

Rabbeted latch and strike kit finishes: 606, 626. This kit adapts square corner latches and strikes for 1/2" (13 mm) rabbeted door and frame preparations.

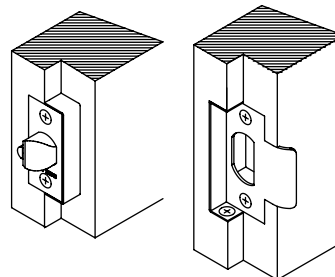

Rabbeted latch and strike kit
39-030

Ordering instructions

Example													
Line item	Qty	Product	Outside		Inside		Hand	Latch	Strike	Dr thk	Ext	Dim	Additional details
			Des	Fin	Des	Fin							
1	10	AL53PD	SAT	626	NEP	619	-	11-096	10-025	200	EE	-	-

Line item: Line item number

Qty: Quantity

Product: Product function + cylinder code

Outside des: Outside lever design

Outside fin: Outside finish

Inside des: Inside lever design - Specify only if different from outside lever design

Inside fin: Inside finish - Specify only if different from outside finish

Hand: Hand of door - N/A for A lock

Latch: Product latch - Leave blank for standard latch or specify part number if non-standard latch is required

Strike: Product strike - Leave blank for standard strike or specify part number if non-standard strike is required

Dr thk: Door thickness - Enter door thickness if non-standard (example: 138=1³/₈"; 214=2¹/₄")

Ext: Extension - Enter for doors 1⁷/₈" or greater (example: EE=extended equally; EI=extended inside; EO=extended outside; ED=extended differently)

Dim: Dimension - Enter only for non-standard strike lip length

Additional details: Enter additional detail for keying information or special requirements

Specifications

Handing:

Non-handed.

Door thickness:

1³/₈" to 1⁷/₈" (35 mm to 48 mm) standard.

2" (51 mm) optional.

Backset:

2³/₄" (70 mm) standard. 2³/₈" (60 mm), 3³/₄" (95 mm) and 5" (127 mm) optional.

Front:

Steel. 2¹/₄" x 1¹/₈" square corner, beveled, for 2³/₄" backset standard. Optional 1" square corner, 1" radius corner, and non-UL drive-in / round face. For availability with specific backsets, see page 16.

Lock chassis:

Steel, zinc dichromated for corrosion resistance

Latch bolt:

Brass, chrome plated, 1/2" throw, deadlocking on keyed and exterior functions.

Exposed trim:

Wrought brass and bronze. Levers are pressure cast zinc, plated to match finish symbols.

Strike:

ANSI curved lip strike 4⁷/₈" x 1¹/₄" x 1¹/₄" lip to center standard. Optional strikes, lip lengths and ANSI wrought strike box available. See page 17.

Cylinder and keys:

6-pin patented Everest 29 S123 keyway standard with two nickel silver keys per lock.

Keying options:

Interchangeable core and Primus® high security cylinders. Master keying, grand master keying, and construction keying.

Warranty:

Three-year limited.

Certifications

ANSI:

Meets or exceeds A156.2 Series 4000, Grade 2 strength and operational requirements.

Meets A117.1 Accessibility Code.

Federal:

Meets FF-H-106C.

California State Reference Code:

(Formerly Title 19, California State Fire Marshal Standard)

All levers with a return to door of 1/2" (64 mm)

or less comply.

UL / cUL:

All locks listed for A label single doors, 4' x 8'.

Letter F and UL symbol on latch front indicate listing.

UL437 Listed locking cylinder optional: specify Primus 20-500 Series cylinder.

ADA compliant:

Schlage Lock Company offers a wide selection of locks designed to meet the Americans With Disabilities Act.

Product identification

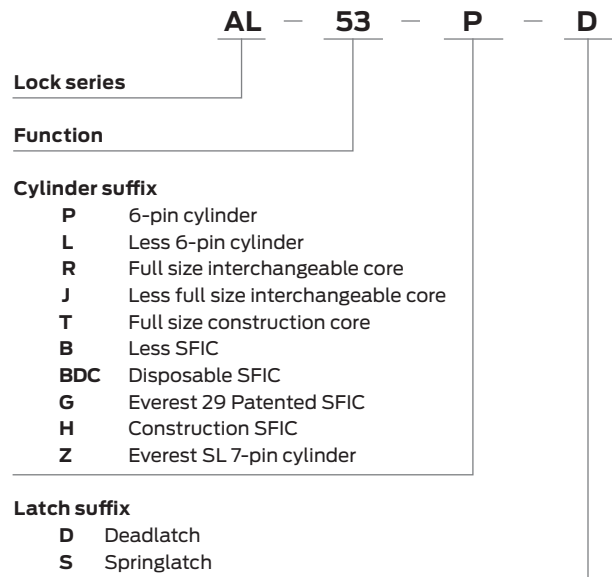

Note: SFIC = Small Format (Best® Style) Interchangeable Core

About Allegion

Allegion (NYSE: ALLE) is a global pioneer in safety and security, with leading brands like CISA®, Interflex®, LCN®, Schlage®, SimonsVoss® and Von Duprin®. Focusing on security around the door and adjacent areas, Allegion produces a range of solutions for homes, businesses, schools and other institutions. Allegion is a \$2 billion company, with products sold in almost 130 countries.

For more, visit www.allegion.com

KRYPTONITE ■ LCN ■  ■ STEELCRAFT ■ VON DUPRIN